

**OIL
BATH
AIR
FILTERS**

- MERCEDES
- MAN
- **VOLVO**

- DEUTZ
- PANCAR
- **ZETOR**

- LOMBARDINI
- TUMOSAN
- **JOHN DEERE**

MK GROUP
WINCHENZO
www.winchenzo.com



24
YEARS

2024
**PRODUCT
CATALOG**

of experience and
excellence in
industry and trade
for our customers



WINCHENZO HEAVY
TRUCK EQUIPMENT

sales@winchenzo.com

MK101101

Product picture

Ürün resmi

OEM

Original number

Machine model - Makina model -

MK 1 01 1 01

A B C D E

A : Factory code - Fabrika kodu

B : Type of th vehicle - Aracın türü

C : Vehicle name - Araç adı

D : Product type - Ürün tipi

E : Series of the product



MERCEDES

BENZ

2024

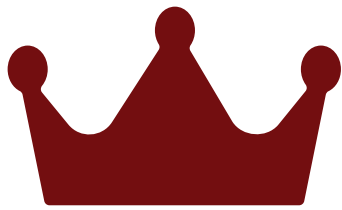

MK101101



Spare parts Yedekparça



OEM

A 0160948802
A 0160945702

1635 - 1629 - 1636 - 1632 - 1628

MKMK09

MKMK012

MK909901

MK101102



MK909901

MKMY04

MKMY08

OEM

A 0120946202
A 0150948302

1744 - 1738 - 1735 - 1733 - 1935

MKMY09

MKMY167

MKMY221

MK101103



Spare parts Yedekparça



OEM

A 0160948802
A 0160945702

1622 - 1619 - 1629

MKMSK09

MKMK013

MK909903

MK101104



OEM

A 0050946802

1628- 1624

MK101105



OEM

A 0050946802

1628- 1624

MK101106



OEM

A 0090946502
A 0000943004

2521 - 2517

MK101107



OEM

A 0100941202
A 0100941204

1922- 2622- 2629- 2628- 2637

MK101108



OEM

2622

MK101109



OEM

A 0160945702

3031 - 2629 - 2628

Important notice

ALL ORIGINAL NUMBERS, MARKS AND MODELS FROM VEHICLE MANUFACTURERS LISTED IN THIS CATALOGUE ARE FOR COMPARISON PURPOSES ONLY . AND MAY NOT BE USED IN INVOICES TO VEHICLE OWNERS OR RESELLERS .

OIL BATH AIR FILTERE
filtre à air à bain d'huile
yağ banyosu hava filtresi
Воздушный фильтр
масляной ванны

MK101110



4038

MK101111



302 TRUCKS

MK101112



1923 - 1935

MK101113

A(mm) = 600
B(mm) = 370
C(mm) = 180.130
D(mm) = 145

OEM

A 9585200353
A 9585200553



AXOR 4140-3240-1840

MK1011??

OEM

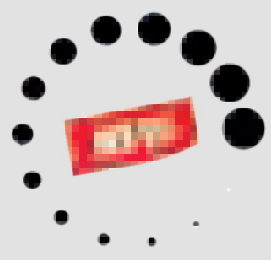

Vehicle model

Write Your Note

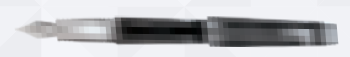

MK101201

Spare parts Yedekparça

OEM

A 0160948802
A 0160945702



1635 - 1629 - 1636 - 1632 - 1628

شفت امامی

MK191201

MK101202

OEM

A 0160940602



1738 - 1735

MK101203

OEM

A 0160940602



1738 - 1735

MK101204

OEM

A 0160940602



1738 - 1735

Spare parts Yedekparça



MKMOV63

MKMOV612

MKMOV60

MK101005

OEM

A 0180946302
A 0190941102



MK191005

Height [mm]: 332,3

Outer diameter [mm]: 406

Inner diameter 1 [mm]: 221,8

OEM

A 0040942504



AXOR 2529 - 3028

MK101006

OEM

A 9585200353
A 9585200553



MK199006

OEM

0010944603



AXOR 4140-3240-1840

MK101008

OEM

A 0090946902



2622

MK101009

OEM

A 3860908501



1630

MK101010

OEM

A 0070946202
A 3080947002



L608E - L708E

MK101010

OEM

A 4760900601
A 4760900001



1420-1418 - 1723-1720-1718

MK101013



OEM

A 3860908401

1620 L

MK101010



OEM

A 6345280006

LS1634

MK101015



OEM

A 3740908401

1624 - 1622

MK101216



OEM

A 4760907101

2638 - 1938

Теперь вы можете
отслеживать доставку
через наш веб сайт
введя код конверсии
указанный в
автоматической
системе заполнения
которая входит в
счет проформу

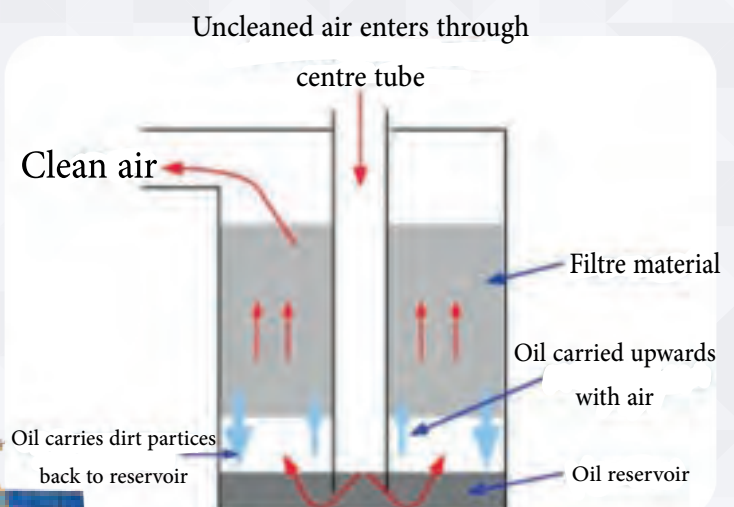

MK101217



OEM

A 9735280606

ATEGO 1517-

MK101218



OEM

A 0140949302

2422 - 1722 - 1820 - 1824

MK101220



OEM

A 0190942902

ACTROS EURO 5

MK101221



OEM

A 3740900301

914 - 712C

MK101222



OEM

A 0190944502

ACTROS EURO 6

MK101223



OEM

A 3760903301

L1620

MK101224



OEM

A 6880947002

LO 813 D710-

MK101225

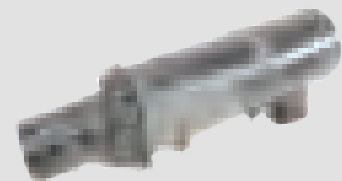

OEM

A 9570940202

ECONIC

MK101601



OEM

A 9424901301

ACTROS-AXOR-AXOR2

MK101602



OEM

A 9424901501
A 9424902501

AXOR - AXOR 2 - ACROS

MK101603



OEM

A 9424902601

AXOR-ACROS

MK101604



OEM

A 9424901401

ACTROS

MK101605



OEM

A 9424901601
A 9424902801

AXOR - AXOR 2 - ACROS

MK101606



OEM

A 9424902601

AXOR-ACROS

MK101607



OEM

A 3754900001

ATEGO

MK10160



OEM

A 6454902001

1948-1735-1748-1840-1844-1935

MK101609

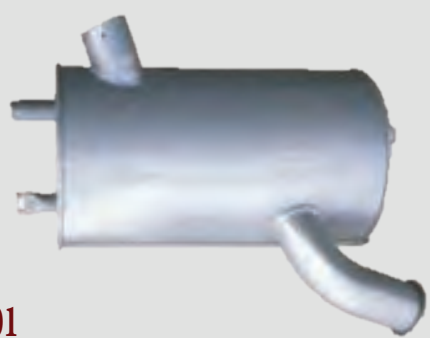

OEM

A 9404900501

AXOR2

MK101611



OEM

A 9424922830

AXOR - ACTROS

MK101612



OEM

A 9424922730

AXOR - ACROS



MK101701



OEM

A 0000185735

2521

MK101702



OEM

A 0000185835

AXOR 3340 - 4140

MK101703



OEM

A 0000183835

2524-2521-2517

MK101705



OEM

A 4030100162

MERCEDES - MAN

MK101706



OEM

A 3520100162

MERCEDES - MAN

MK101226

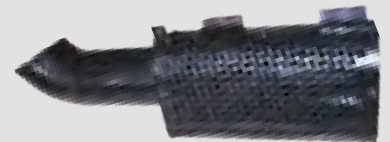

OEM

A 0008300053

2636 - 3031 - 2524 - 2521

MK101227

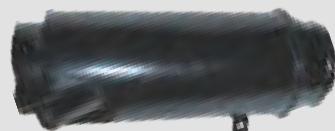

OEM

A 0160941402

2636 - 2622 - 3031 - 2521

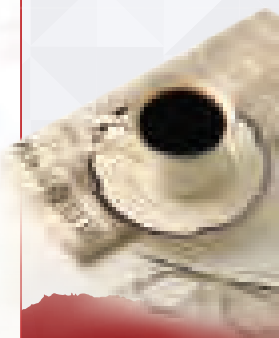
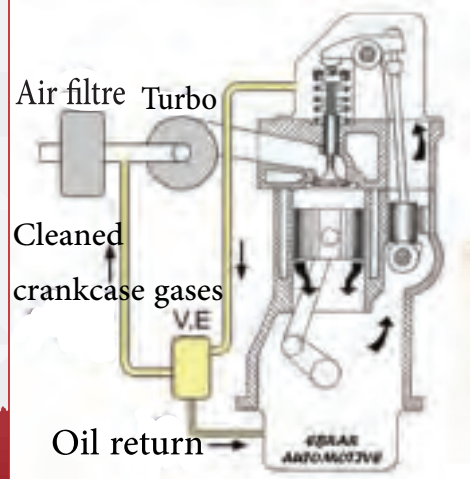

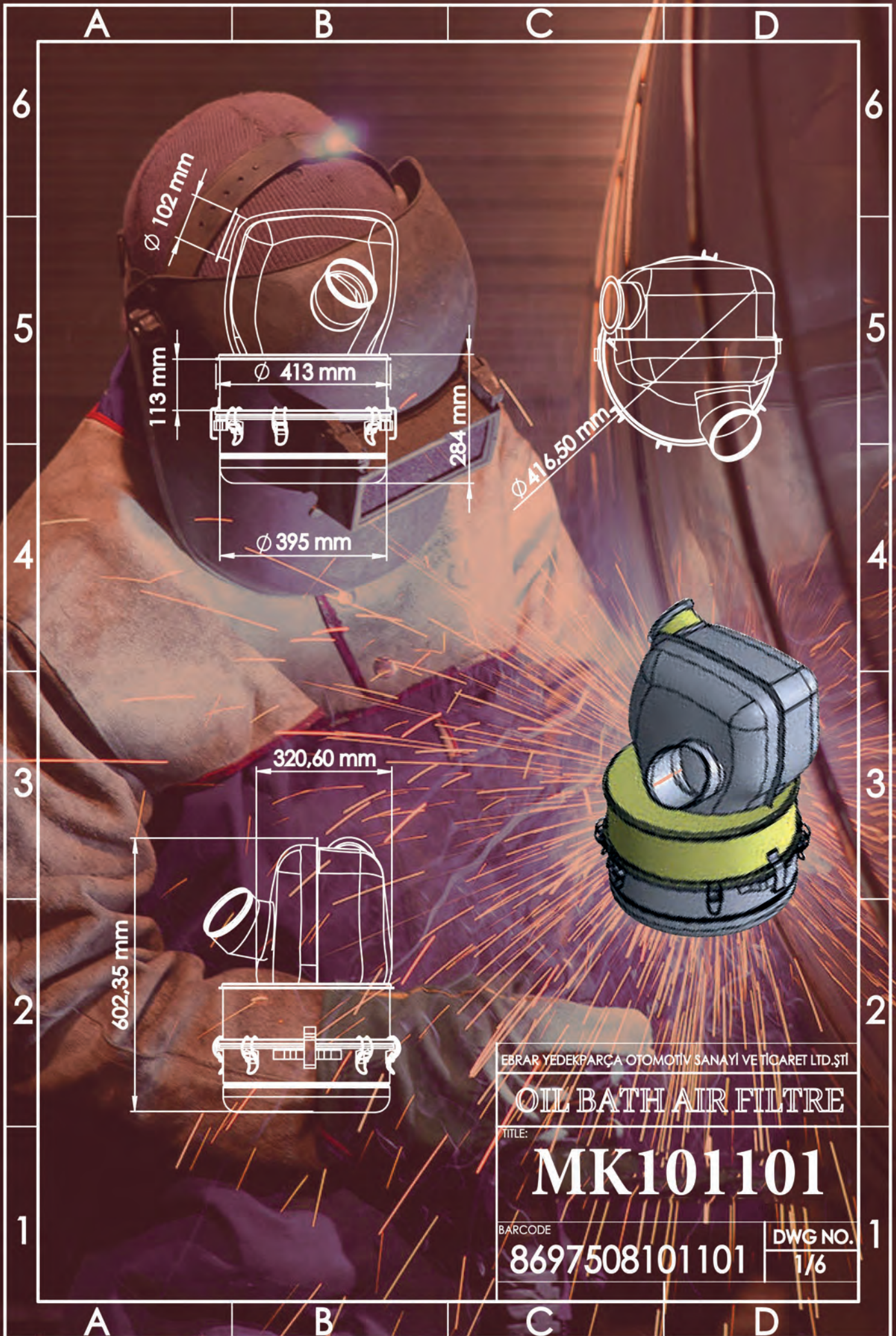

EBRAR YEDEKPARÇA OTOMOTIV SANAYİ VE TİCARET LTD.ŞTİ

OIL BATH AIR FILTRE

TITLE:

MK101101

BARCODE

8697508101101

DWG NO.

1/6

Our products

Ürünlerimiz

Наши продукты

Nos produits

2024

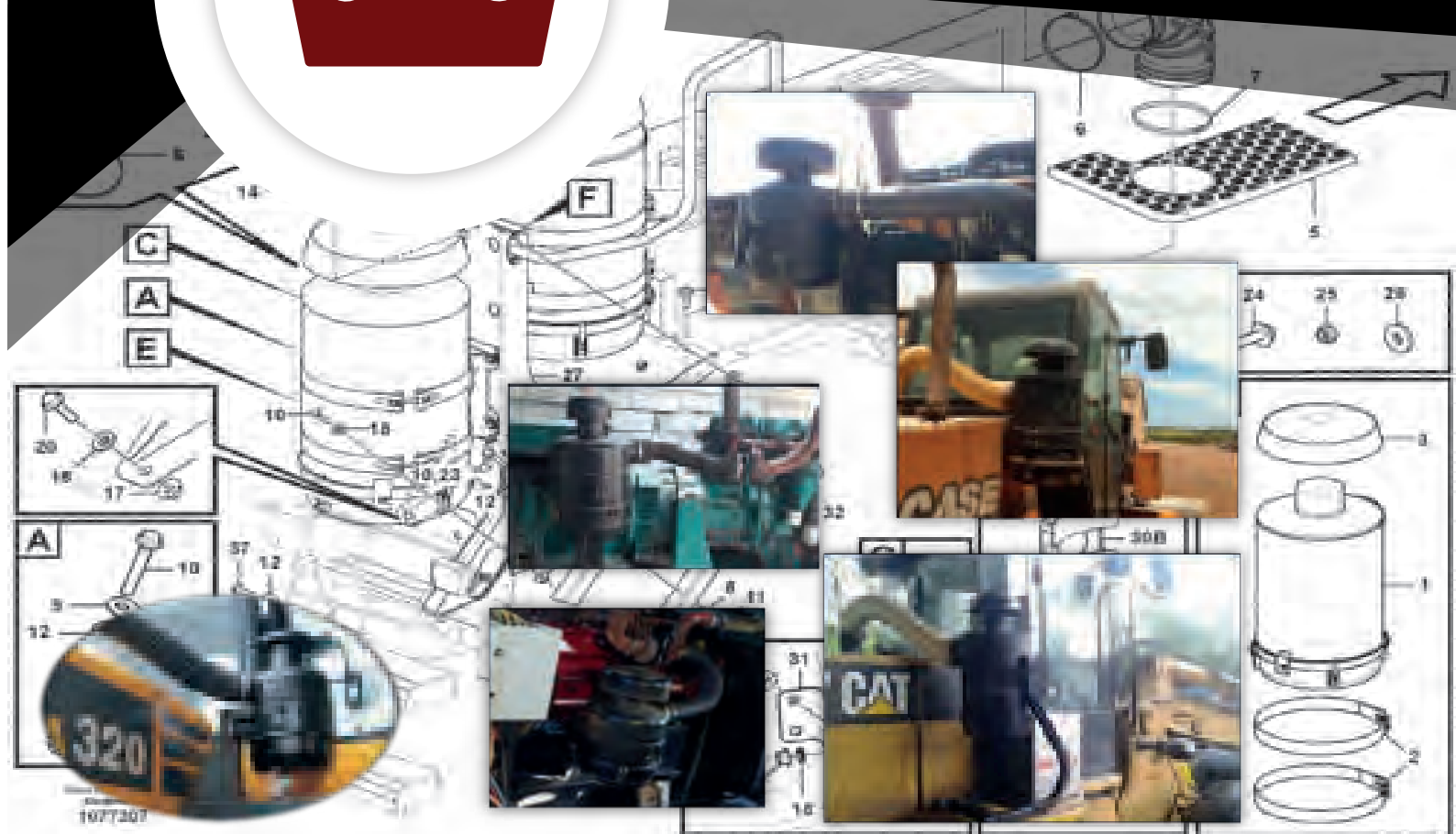
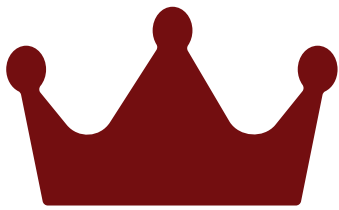

MK302103 - MK102103

Height A(mm)= 580
Diameter B(mm)= 315
Inlet diameter C(mm)= 100
outlet diameter D(mm)= 100



Generator - Constraction machinery

MK302109 - MK202109

A(mm)= 510
B(mm)= 230
C(mm)= 80
D(mm)= 80



Generator - Constraction machinery

MK302101 - MK102101

Yükseklik A(mm)= 700
Beden çapı B(mm)= 340
Giriş çapı C(mm)= 120
Çıkış çapı D(mm)= 120



Generator - Constraction machinery

MK302102 - MK102102

Hauteur A(mm)= 610
Diametre B(mm)= 340
Diamètre d'entrée C(mm)= 120
D iamètre de sortie D(mm)= 120



Generator - Constraction machinery

MK302104 - MK102104

Рост A(mm)= 615
Диаметр B(mm)= 395
Входной диаметр C(mm)= 128
диаметр выхода D(mm)= 128



Generator - Constraction machinery

MK302150



Special work machines

MK302153



Special work machines

MK302155



Special work machines

MK302156



Air compressor

MK302157



Special work machines

MK30215



Air compressor

MK302159



Tractor

MK302160



Air compressor

MK302161



Special work machines

MK302162



Special work machines

MK302163

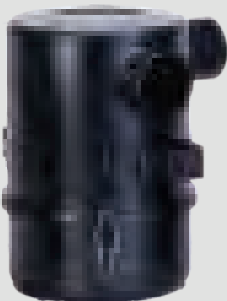

Special work machines

MK302164



Special work machines

MK302151



Agricultural machine

MK302152



Agricultural machine

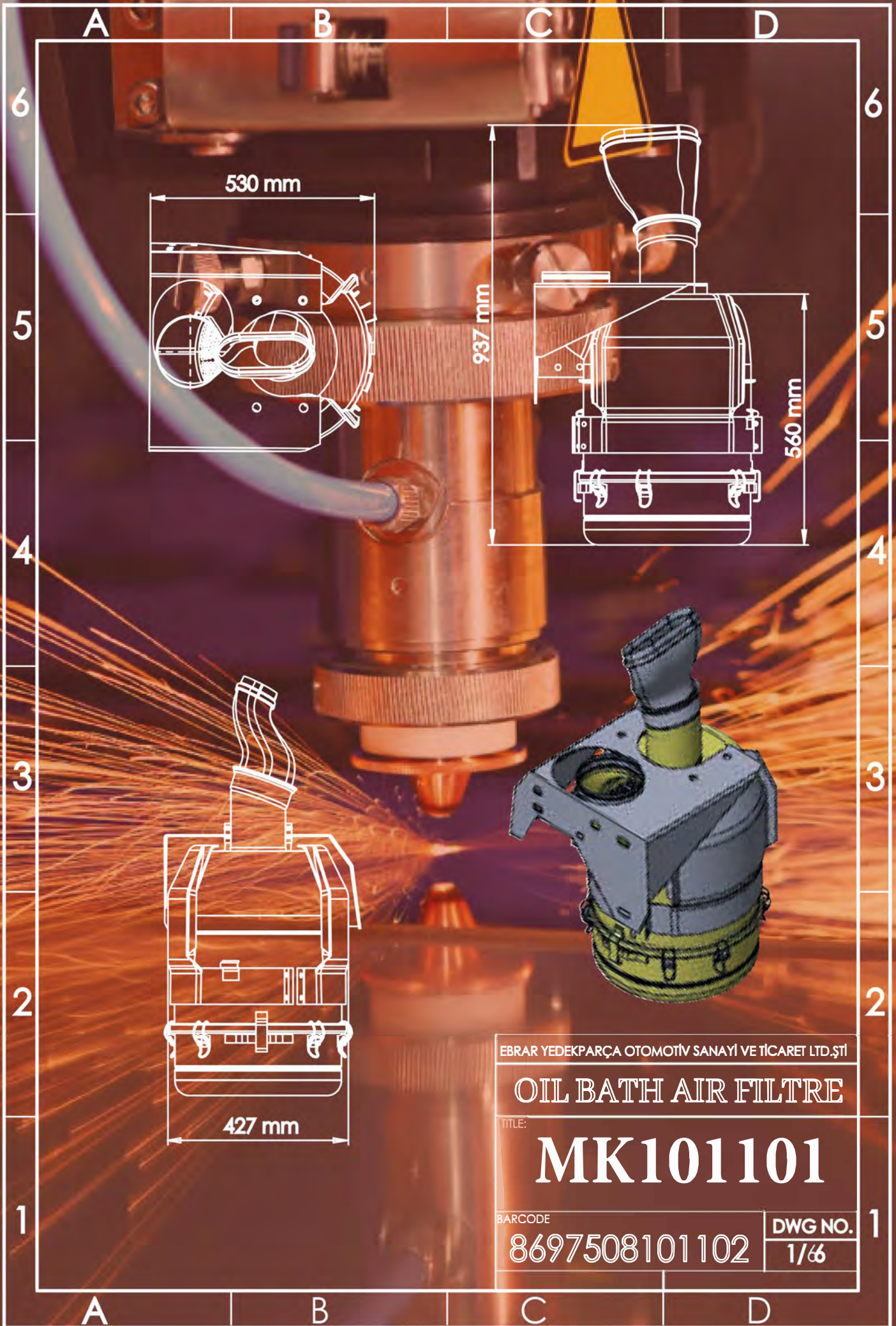

EBRAR YEDEKPARÇA OTOMOTİV SANAYİ VE TİCARET LTD.ŞTİ

OIL BATH AIR FİLTRE

TITLE:

MK101101

BARCODE

8697508101102

DWG NO.

1/66

MAN

2024

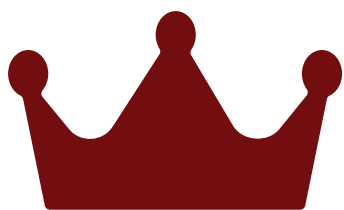

MK106101

Oil bath
air filtre

OEM

83083017502



321-281-26.280

MK106102

Oil bath
air filtre

OEM

81083120003

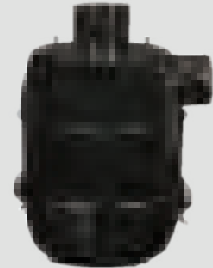

26.210

MK106201

OEM

8108406169



26.230-26.270

MK106202

OEM

81084006006



19.464-19.466

MK106203

OEM

81083016281



163-12.153

MK106204

OEM

81084006009



19.422

MK106205

OEM

81083040097



163-12.153

MK106206

OEM

81084006018



TGA / TGS / TGX

MK106601

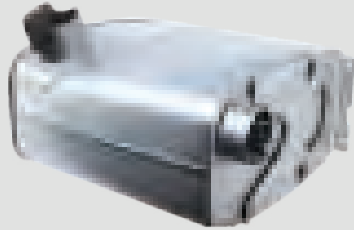

OEM

81151010346

TGA - ECT

MK106602



OEM

81151010345

TGA - ECT

MK106603

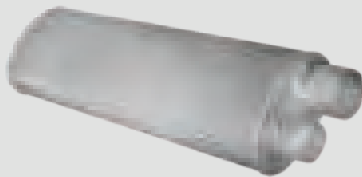

OEM

64151010001

L-2000M90

MK106701



OEM

51018047023

26.281

MK106702



OEM

51018047028

19.422

MK106703



OEM

51018047032

TGA

MK106704



OEM

51018047037

TGA LX LOW CABIN / 430-410

MK106???

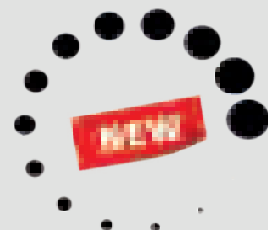

OEM

Vehicle model

A

B

C

D

6

6

5

5

4

4

3

3

2

2

1

1

A

B

C

D

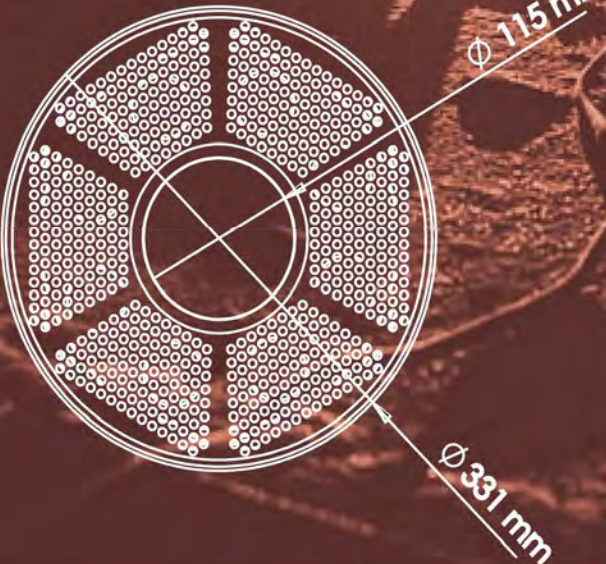
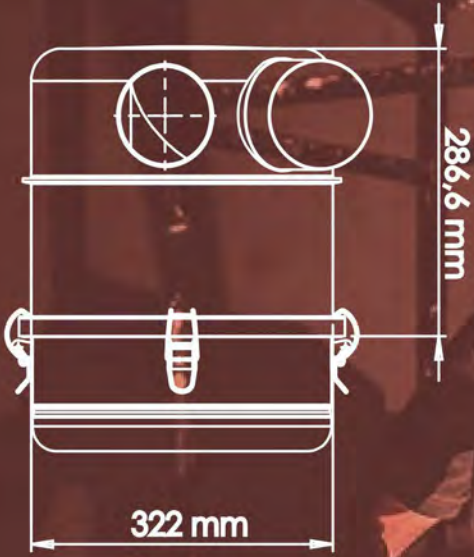

EBRAR YEDEKPARÇA OTOMOTİV SANAYİ VE TİCARET LTD.ŞTİ

OIL BATH AIR FİLTRE

TITLE:

MK101104

BARCODE

8697508101104

DWG NO.

1/6

IVECO

2024

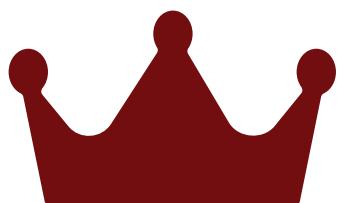

OIL BATH AIR FILTRE
filtre à air à bain d'huile
yağ banyosu hava filtresi
Воздушный фильтр
масляной ванны

MK107101



OEM

8137427

EUROTECH

MK107102



OEM

135 TRUCK

MK107103



OEM

85.12 TRUCK

MK107105



OEM

4997379

65.9

MK107106



OEM

4644189

697.684.619.169

MK107???

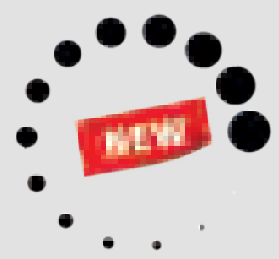

OEM

Vehicle model

MK107201



OEM

8137427

EUROTECH

MK107202



OEM

504079907

DAILY 2006-2005

MK107203



OEM

41201403

CURSOR TRAKKER

MK107204



OEM

41226559

Luchtfilterhuis Stralis

MK107205



OEM

41226559

Luchtfilterhuis Stralis

MK107???

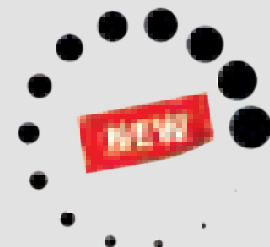

OEM

Vehicle model

MK107601



OEM

5801269048

Euro Cargo truck

MK107602



OEM

41020590

TRAKKER

MK107603

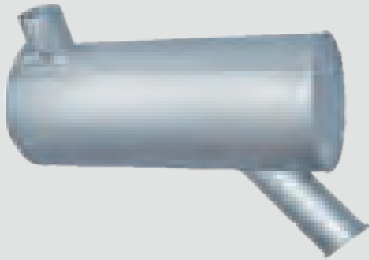

OEM

8137212

EUROTECH /STAR

MK107701



OEM

98437363

330-190

MK107702



OEM

61320629

EURO TECH-STAR-TRAKKER

MK107???

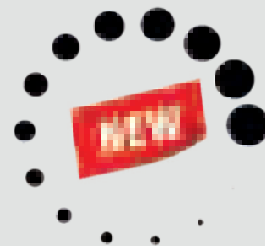

OEM

Vehicle model

VOLVO

2024

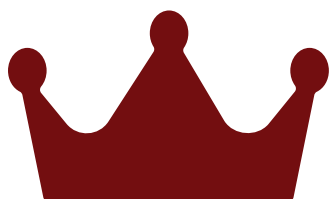

MK108101

Oil bath
air filtre

OEM



TATRA

MK108102

Oil bath
air filtre

OEM

11110614



11110614 - 11033550

MK108201

OEM

21115481



FH4

MK108202

OEM

3979505



FH2

MK108203

OEM

20707666



FE - FL

MK108204

OEM

20728816



FE - FL

MK108205

OEM



VN610 - VNL 2016

MK108206

OEM

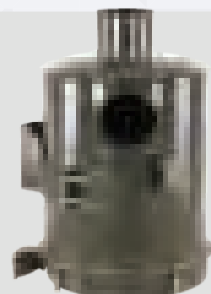

TATRA

MK108207



OEM

8237018 - 82377018

TWD1211G TWD1010G0

MK108208



OEM

3826215

VOLVO PENTA

MK108209

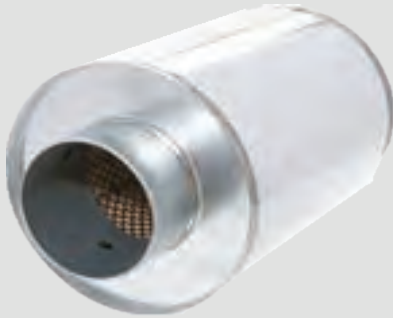

OEM

17280-60.70.100.102120.121.122.162.165

MK108601



OEM

1676499

FM-7FM-10FL12

MK108602



OEM

3979599 - 3979909

FH-16FH-12FH-FN-FM-9FM-10FM12

MK108603

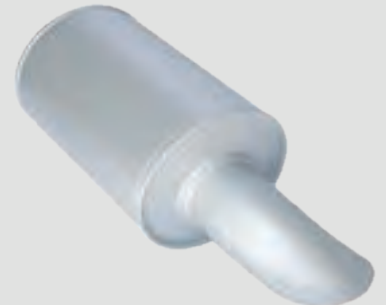

OEM

EURO 5/4

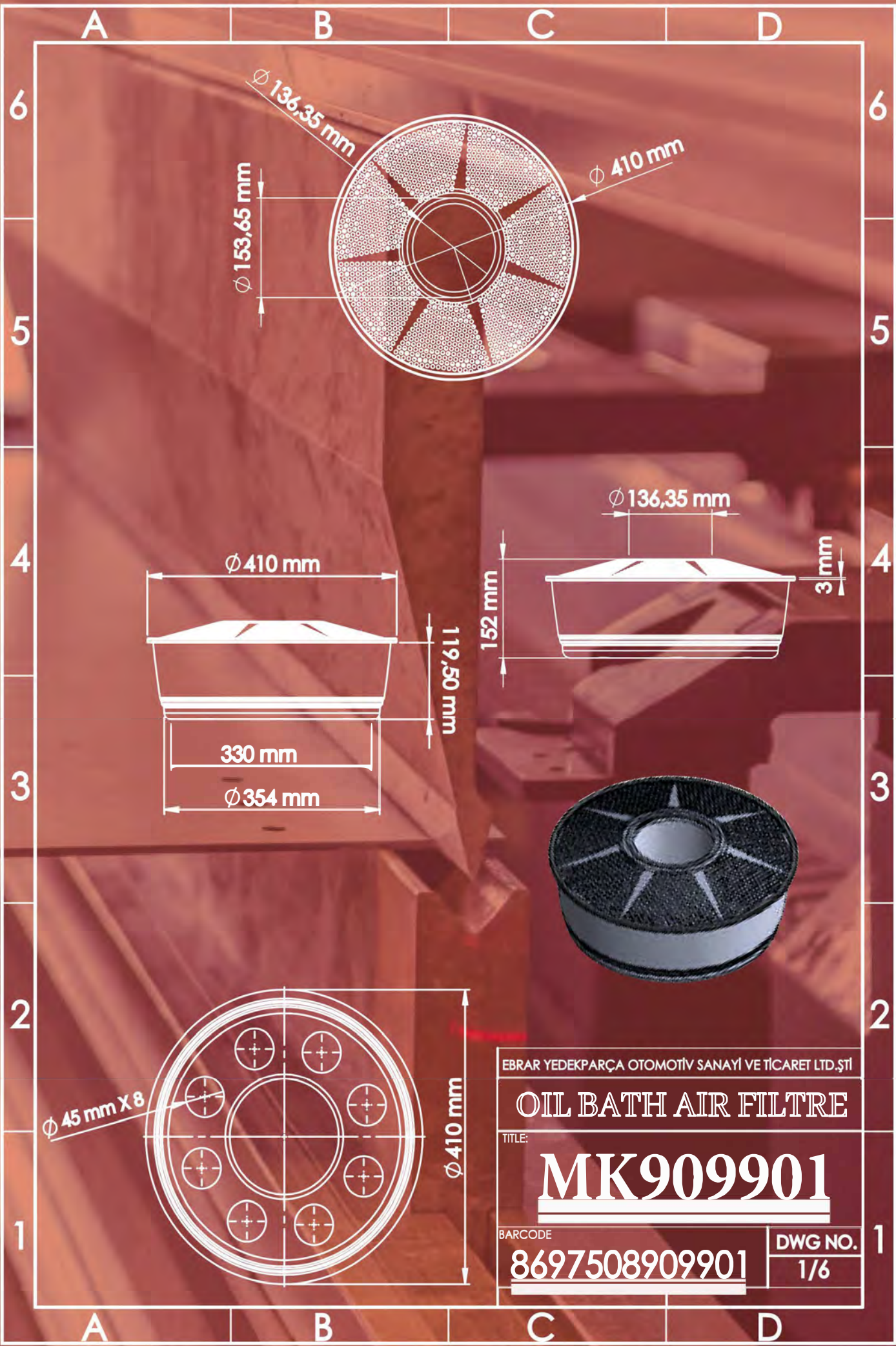

EBRAR YEDEKPARÇA OTOMOTİV SANAYİ VE TİCARET LTD.ŞTİ

OIL BATH AIR FİLTRE

TITLE:

MK909901

BARCODE

8697508909901

DWG NO.

1/6

SCANIA

2024

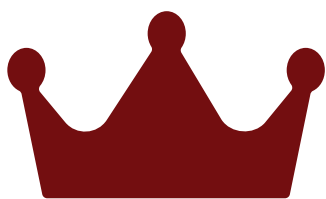

MK109101

Oil bath
air filtre

OEM



Spare parts Yedekparça



D11

MK 1-108101

MK 2-108101

MK109201

OEM

1506546



6 SERIES

MK109202

MEDIUM-
ORTA

OEM

1387542



-144-124-94S80.8207

MK109203

SMALL-
KÜÇÜK

OEM

1335674



S80.8208

MK109204

HIGH-
BÜYÜK

OEM

1335673



S80.8182

MK109601



OEM

1387823

4/P/G/R/T

MK109602

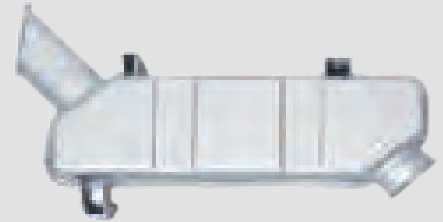

OEM

1821888

P/G/R/T (EURO 5)

MK109603



OEM

357402

3/2 SERİSİ

MK109???

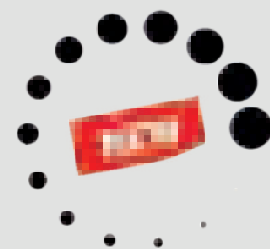

OEM

Vehicle model

Benefits of Truck Mufflers

Increased horsepower : Adding a new muffler to your truck can increase the total amount of horsepower from your engine.

You can get a boost in power behind the wheel while at the same time increasing your overall performance as well.

Enhanced airflow : A new muffler can boost your entire exhaust system. The component can eliminate backpressure .

and allow more air to travel through the system. This will increase your engine's performance and can increase gas mileage.

Improved sound : Swapping out your old muffler and exhaust pipes can drastically increase the amount of noise your car produces.

If you drive a sporty truck and want to make an entrance, consider a muffler that adds a low grumble to your exhaust.

A

B

C

D

6

6

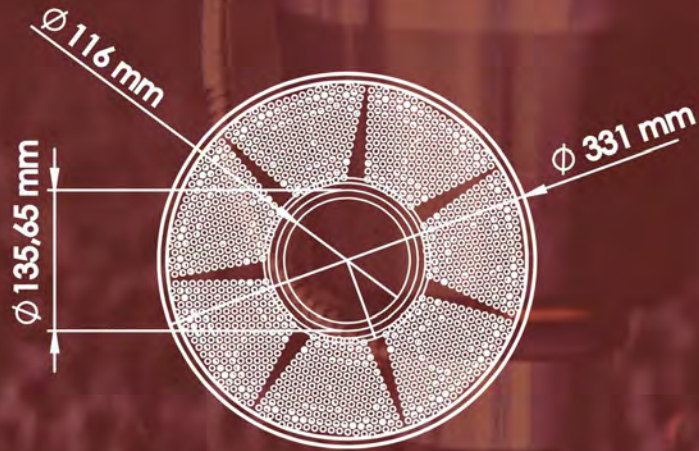

5

5

4

4

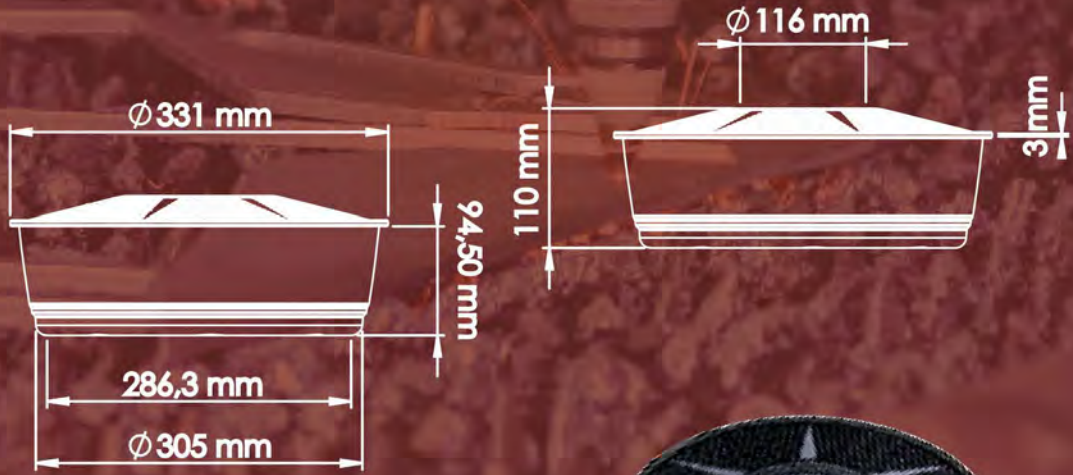

3

3

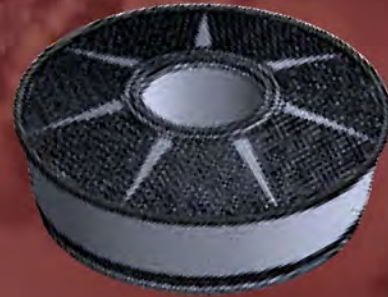

2

2

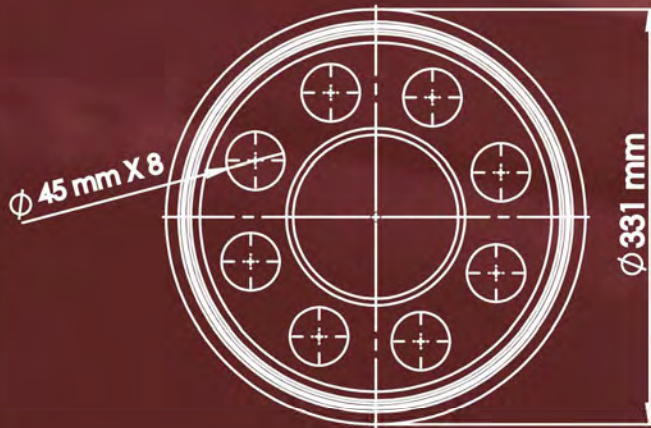

1

1

EBRAR YEDEKPARÇA OTOMOTİV SANAYİ VE TİCARET LTD.ŞTİ

OIL BATH AIR FİLTRE

TITLE:

MK909902

BARCODE

8697508909902

DWG NO.

1/6

A

B

C

D

RENAULT

DAF

ISUZU

2024

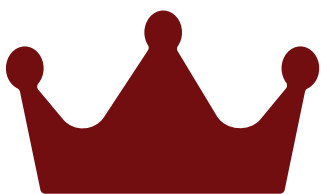

MK104201



OEM

5010230544

PREMIUM 1

MK104202



OEM

501062116

PREMIUM 3-2

MK104601

EXHAUST - EGZOZ
ВЫХЛОП -



OEM

742056405

MAGNUM-KERAX

MK104602

EXHAUST - EGZOZ
ВЫХЛОП -

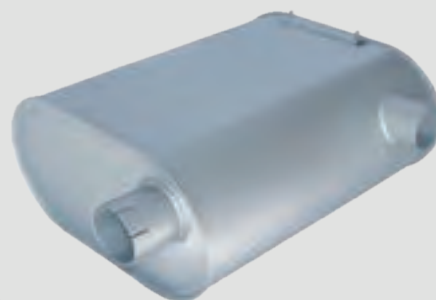

OEM

5010230752

PREMIUM EURO 3

MK104603

EXHAUST - EGZOZ
ВЫХЛОП -

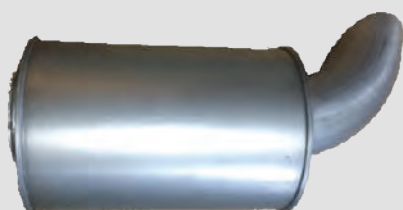

OEM

7420534879

EURO5/ 4 - MAGNUM

MK104???

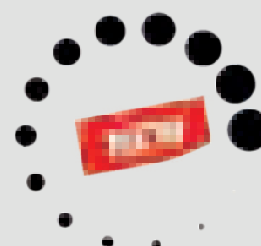

OEM

Vehicle model

MK105201



OEM

1638005 - 1789397

CF

MK105202



OEM

1686324

XF

MK105203



OEM

1402661

LF 55/45

MK105601

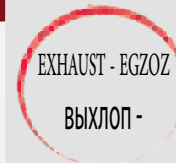

OEM

1438192 - 1321301

-95XF-95CF-85CF-75CF85 -65CF

MK105602

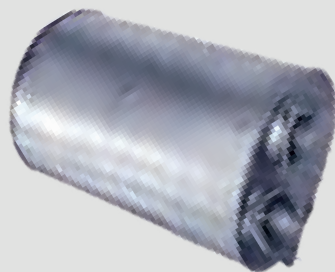
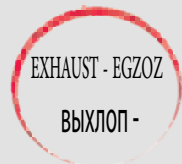

OEM

555004 - 1301422

95 FUTURA

MK105???

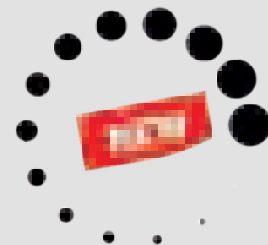

OEM

Vehicle model

MK110201



ISUZU

MK110202



ISUZU

MK110101



ISUZU

MK110???

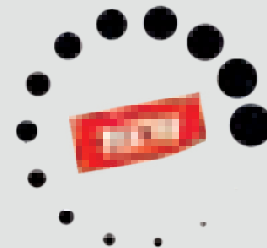

OEM

Vehicle model

Maintenance & Composition

The oil in the cup must always be maintained at the level indicated. Make sure that the cup is free of mud and other impurities which might accumulate during working. When working in particularly dusty environments, the lower parts of the filter should be dismantled every day and cleaned with diesel fuel.

The filter must always be mounted in the vertical position. Tilts of up to 30° are acceptable, and also greater tilts for short periods of time, Working temperature from 0°C to 90°C, Use medium density oil, If the oil is changed on a regular basis, only minimal maintenance operations are necessary.

DEUTZ

2024

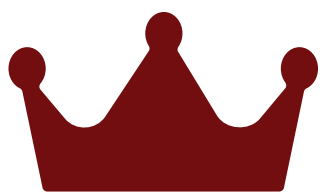

MK303106



F2L-912F2L912W511-

MK303105



F2L511-912

MK203105



F2L511-912

MK303101



F3L-912F4L912

MK303102



F3L-912F4L912

MK203101



F3L-912F4L912

MK203102

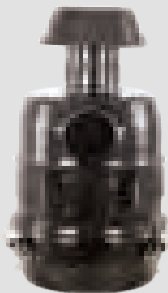

F5L-912F6L912

MK303104



F5L-912F6L912

MK303103



F5L-912F6L912

MK303143



F3L912

MK303144



F4L912

MK303146



F6L912

MK303132

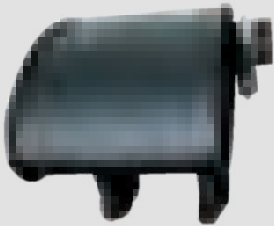

F2L912

MK303133



F3L912

MK303134



F4L912

MK303135

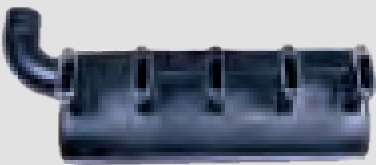

F5L912

MK303136



F6L912

MK303???

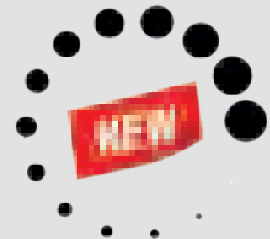

ENGINE MODEL

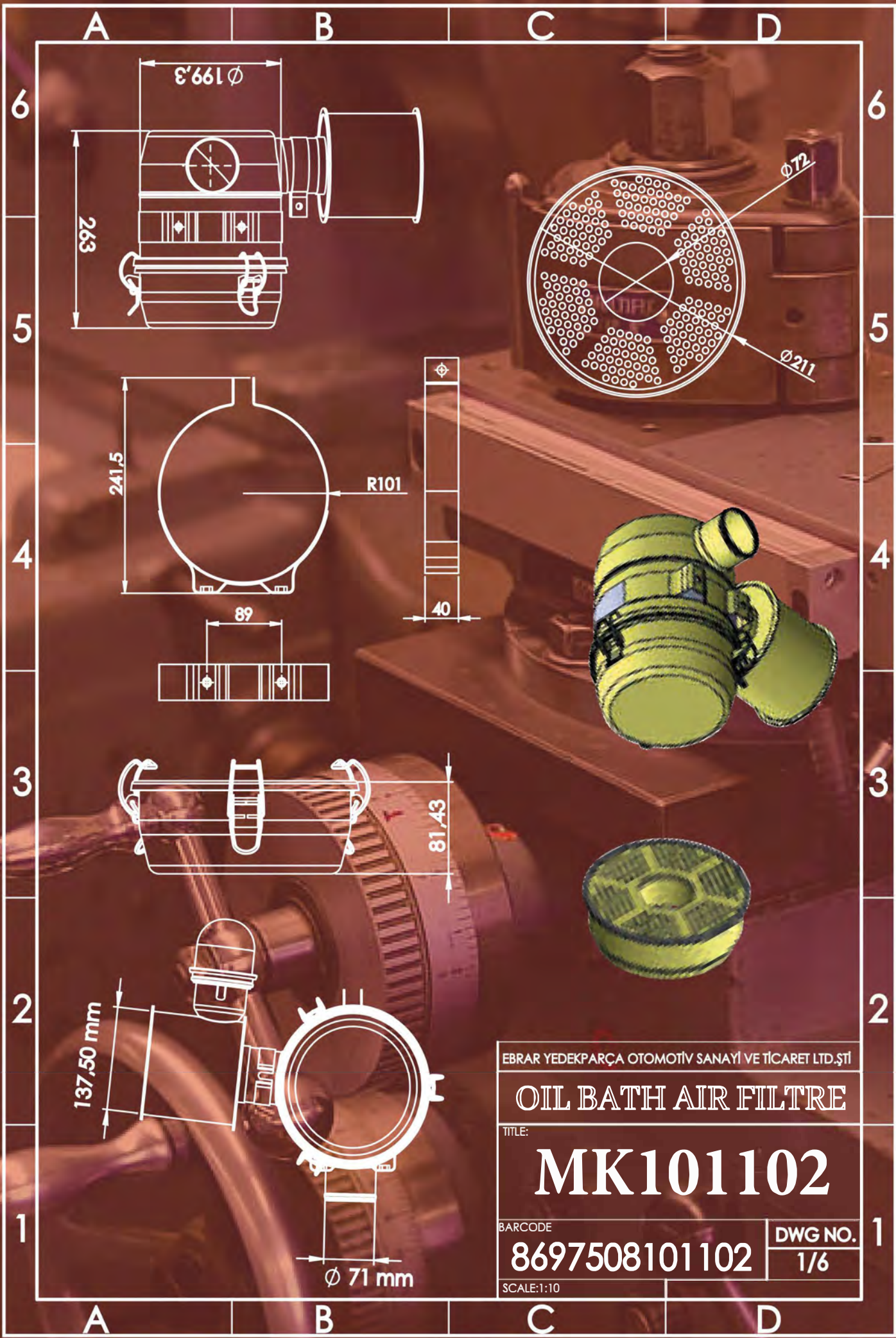

EBRAR YEDEKPARÇA OTOMOTİV SANAYİ VE TİCARET LTD.ŞTİ

OIL BATH AIR FİLTRE

TITLE:

MK101102

BARCODE

8697508101102

DWG NO.

1/6

SCALE:1:10

ZETOR

MASSEY FERGUSON

2024

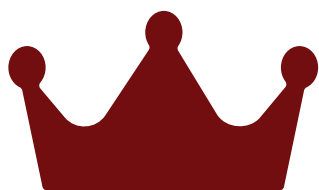

MK204101

Zetor

OEM

69011201



3320-7045-7745-5011

MK204102

Zetor

OEM

69011201



4718-4712

MK206101

MF

OEM

898390M91



185-175-165

MK206102

MF

OEM

883914M94



240-135-B1615NEW

MK206103

MF

OEM

893227M92



35-550-240-148-135X

MK206104

MF

OEM

1662276M91
880031M91



265-265S-285-285-275S

PANCAR

Air Compressor

2024

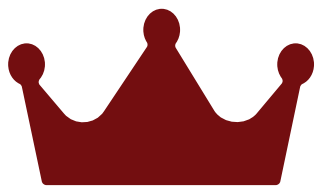

OIL BATH AIR FILTERE
filtre à air à bain d'huile
yağ banyosu hava filtresi
Воздушный фильтр
масляной ванны

MK307101



PANCAR

MK307102



PANCAR Z108

MK307103



PANCAR E89

MK307104



PANCAR

MK307105



PANCAR

MK307106



PANCAR

MK307701

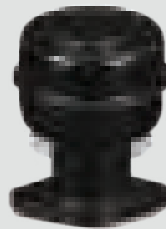

PANCAR

MK307702

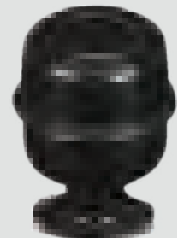

PANCAR - RF

FORD

& FIAT

2024

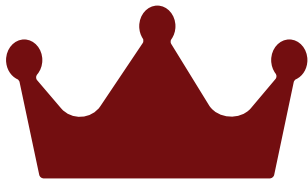

MK210101



OEM

C5NE9600E

4000-5000

MK210102



OEM

D3NN9600F

4600-6600

MK210103



OEM

E6NN9600GB

6810-6610-6410-5610-5110

MK210104



OEM

7250053
7251512

780

MK210105



OEM

8323083
5136558

80.66-55.46

MK210106



OEM

4987730
5116972

480-450

MK210201



OEM

5097073
5150017

L85 - L95 - TL85 - TL95

MK210202



OEM

5157064
5097072

-80.66TD-65TD85D-TD75 - TD85

MK210203



OEM

8N9600B

8N FITS

MK210204



OEM

1389435080

Ducato 250

MK210205



OEM

2-5153784

-80.66TD-65TD75

MK210701



OEM

4955740
4997662

80.66- 415

A B C D

6 6

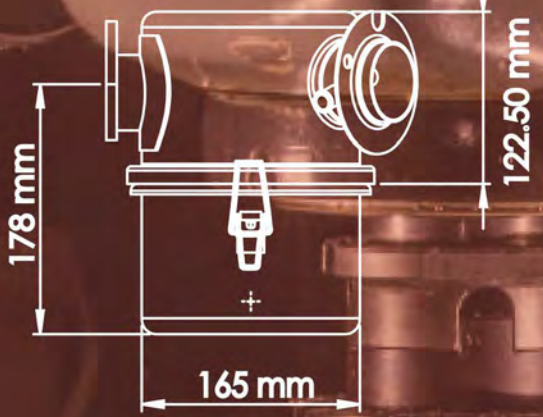

5 5

4 4

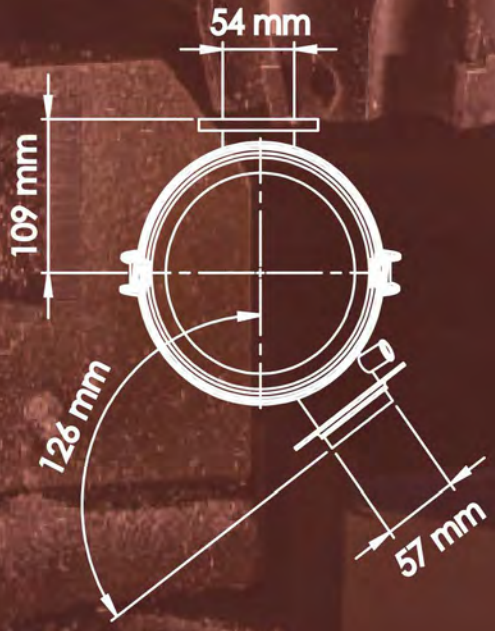

3 3

2 2

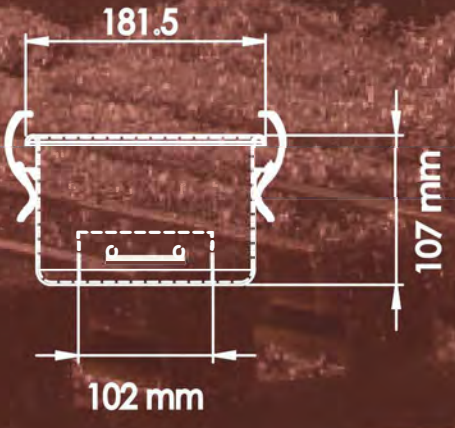

1 1

EBRAR YEDEKPARÇA OTOMOTİV SANAYİ VE TİCARET LTD.ŞTİ

OIL BATH AIR FİLTRE

TITLE:

MK302153

BARCODE

8697508302153

DWG NO.

1/6

A B C D

LOMBARDINI

2024

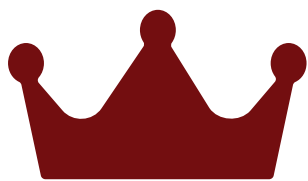

MK211101



LOMBARDINI 820/640

MK211102



LOMBARDINI 510

MK211103



LOMBARDINI

MK211104



LOMBARDINI 450/E108

MK211105



LOMBARDINI 450

MK211601



LOMBARDINI

MK211602



LOMBARDINI

MK211603



640-510-450

MK211???



ENGINE MODEL

TÜMOSAN

JOHN DEERE

2024

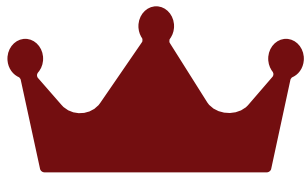

MK242101

oil bath



80-90 80-82 80-74

MK242201



8100 - 8000 - 7100 - 80

MK242202



90-74-7100-4000-70-50

MK242203



90-80-45 Ekonomi

MK209201



6x4 Gators -AM121648

MK209202

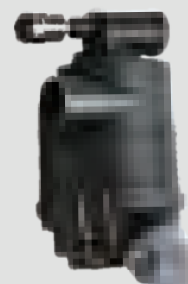

TH Gator 6x4 Diesel

MK209203



CS, HPX, and XUV Gators

MK209204



4x6 ,2x4, TS, TX and TH Gators

MK205101

oil bath



BITICO 4000240



Write your note
Écrivez votre commentaire
Notunu yaz
Напишите свой комментарий

Two columns of horizontal dashed lines for writing notes.

The advantages of an oil bath air filter at a glance :

- ✓ Particularly robust metal design.
- ✓ Maintenance possible without spare parts and during operation.
- ✓ Flow rates of up to 24 m³/min are covered.
- ✓ High degree of effectiveness with only slight loss of pressure.
- ✓ Extended service intervals thanks to large reservoir for dirt capture.

Applications:

Heavy duty machinery, trucks, generators and all machines operating in low to high-level in dust conditions .



Contact information:

Tel: 00905537990980

www.winchenzo.com

sales@winchenzo.com



WINCHENZO

Dalyan Mah. 40462. Sk. No: 19/A - BEYŞEHİR / KONYA - TÜRKİYE